

CENRĀDIS 2013

KERASTAR moduļdūmvads - ar keramikas sirdi





Nerūsējošais tērauds un keramika - perfekta simbioze

- 1a** Pamatelements ar kondensāta izvadu
- 2a/2a-1** Sienas konsole ar kondensāta trauku
- 2c** Sienas konsoles atbalsts 2 gb
- 2d** Sienas konsoles plāksnes 2 gb.
- 3a** Tīrīšanas trejgabals
- 4a** Pieslēguma trejgabals 90°
- 4b** Pieslēguma trejgabala manšete
- 4d** Pieslēguma trejgabals 45°
- 5a** Dūmvada elements 665 mm
- 5b** Dūmvada elements 330 mm
- 5c** Dūmvada elements 165 mm
- 6b** Sienas stiprinājums
- 7** Starpspāru stiprinājums
- 8a** Konuss
- 8b** Konusa lietussargs
- 9a** Izeja caur jumtu 0°
- 9d - 9e** Izeja caur jumtu 3 -45°
- 10a** Lietuskrāga
- 11a/b** Noslēgmanšete
- 13** Distancgredzens
- 14b** Sienas statiskais stiprinājums

CE

090-01-07-0045/1
2007
EN 13063-1
090-01-07-0045/2
2007
EN 13063-2









Kerstar izstrādājumi un papildelementi (Izstrādājums uz pasūtījumu. Pasūtījuma izpildes laiks 3 – 4 nedēļas)

Izstrādājums			Cena bez PVN		gb	Cena ar PVN		
			LVL	EUR	kpl	LVL	EUR	
	681004157	KRS pamatelements ar kondensāta izvadu, Ø140 mm	107,47	152,92	gb	130,04	185,03	
	681004151	KRS pamatelements ar kondensāta izvadu, Ø160 mm	119,33	169,79	gb	144,39	205,45	
	681004158	KRS pamatelements ar kondensāta izvadu, Ø180 mm	127,32	181,16	gb	154,06	219,21	
	681004152	KRS pamatelements ar kondensāta izvadu, Ø200 mm	157,05	223,46	gb	190,03	270,39	
	681004159	KRS pamatelements ar kondensāta izvadu, Ø250 mm	199,22	283,46	gb	241,06	343,00	
	*	681004809	KRS sienas konsole ar kondensāta trauku, Ø140 mm	64,39	91,62	gb	77,91	110,86
	681004155	KRS sienas konsole ar kondensāta trauku, Ø160 mm	68,48	97,44	gb	82,86	117,90	
	681004810	KRS sienas konsole ar kondensāta trauku, Ø180 mm	73,93	105,19	gb	89,46	127,29	
	681004156	KRS sienas konsole ar kondensāta trauku, Ø200 mm	79,13	112,59	gb	95,75	136,24	
	681004811	KRS sienas konsole ar kondensāta trauku, Ø250 mm	103,98	147,95	gb	125,82	179,03	
	681004831	KRS sienas konsoles plāksnes 2 gb., Ø140 mm	33,85	48,16	kpl	40,96	58,28	
	681004161	KRS sienas konsoles plāksnes 2 gb., Ø160 mm	37,72	53,67	kpl	45,64	64,94	
	681004832	KRS sienas konsoles plāksnes 2 gb., Ø180 mm	39,00	55,49	kpl	47,19	67,15	
	681004162	KRS sienas konsoles plāksnes 2 gb., Ø200 mm	39,00	55,49	kpl	47,19	67,15	
	681004833	KRS sienas konsoles plāksnes 2 gb., Ø250 mm	53,77	76,51	kpl	65,06	92,57	
	**	681004812	KRS sienas konsole ar kondensāta trauku, Ø140 mm	74,70	106,29	gb	90,39	128,61
	681004813	KRS sienas konsole ar kondensāta trauku, Ø160 mm	82,63	117,57	gb	99,98	142,26	
	681004814	KRS sienas konsole ar kondensāta trauku, Ø180 mm	88,68	126,18	gb	107,30	152,67	
	681004815	KRS sienas konsole ar kondensāta trauku, Ø200 mm	95,31	135,61	gb	115,33	164,10	
	681004816	KRS sienas konsole ar kondensāta trauku, Ø250 mm	122,68	174,56	gb	148,44	211,21	
	681004871	KRS sienas konsoles atbalsts 2 gb., Ø140 mm	45,05	64,10	kpl	54,51	77,56	
	681004872	KRS sienas konsoles atbalsts 2 gb., Ø160 mm	45,05	64,10	kpl	54,51	77,56	
	681004873	KRS sienas konsoles atbalsts 2 gb., Ø180 mm	45,05	64,10	kpl	54,51	77,56	
	681004874	KRS sienas konsoles atbalsts 2 gb., Ø200 mm	45,05	64,10	kpl	54,51	77,56	
	681004875	KRS sienas konsoles atbalsts 2 gb., Ø250 mm	49,60	70,57	kpl	60,02	85,40	
	681004105	KRS dūmvada elements 165 mm, Ø140 mm	44,99	64,02	gb	54,44	77,46	
	681004101	KRS dūmvada elements 165 mm, Ø160 mm	51,43	73,18	gb	62,23	88,55	
	681004114	KRS dūmvada elements 165 mm, Ø180 mm	48,68	69,27	gb	58,90	83,81	
	681004111	KRS dūmvada elements 165 mm, Ø200 mm	58,91	83,82	gb	71,28	101,42	
	681004117	KRS dūmvada elements 165 mm, Ø250 mm	66,14	94,11	gb	80,03	113,87	
	681004106	KRS dūmvada elements 330 mm, Ø140 mm	55,68	79,23	gb	67,37	95,86	
	681004102	KRS dūmvada elements 330 mm, Ø160 mm	58,95	83,88	gb	71,33	101,49	
	681004115	KRS dūmvada elements 330 mm, Ø180 mm	60,78	86,48	gb	73,54	104,64	
	681004112	KRS dūmvada elements 330 mm, Ø200 mm	69,31	98,62	gb	83,87	119,34	
	681004118	KRS dūmvada elements 330 mm, Ø250 mm	77,09	109,69	gb	93,28	132,73	

* ja dūmvada augstums ir līdz 8m







** ja dūmvada augstums ir līdz 20m

Kerastar izstrādājumi un papildelementi (Izstrādājums uz pasūtījumu. Pasūtījuma izpildes laiks 3 – 4 nedēļas)

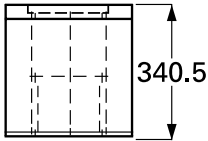
Izstrādājums			Cena bez PVN		gb kpl	Cena ar PVN	
			LVL	EUR		LVL	EUR
	681004107	KRS dūmvada elements 665 mm, Ø140 mm	71,80	102,16	gb	86,88	123,62
	681004103	KRS dūmvada elements 665 mm, Ø160 mm	76,52	108,88	gb	92,59	131,74
	681004116	KRS dūmvada elements 665 mm, Ø180 mm	80,38	114,37	gb	97,26	138,39
	681004113	KRS dūmvada elements 665 mm, Ø200 mm	85,77	122,04	gb	103,78	147,67
	681004119	KRS dūmvada elements 665 mm, Ø250 mm	97,29	138,43	gb	117,72	167,50
	681004144	KRS tīrīšanas trejgbals, Ø140 mm	134,65	191,59	gb	162,93	231,83
	681004141	KRS tīrīšanas trejgbals, Ø160 mm	141,00	200,62	gb	170,61	242,76
	681004145	KRS tīrīšanas trejgbals, Ø180 mm	149,00	212,01	gb	180,29	256,53
	681004142	KRS tīrīšanas trejgbals, Ø200 mm	171,89	244,58	gb	207,99	295,94
	681004146	KRS tīrīšanas trejgbals, Ø250 mm	200,01	284,59	gb	242,01	344,35
	681004123	KRS pieslēguma trejgbals 90°, Ø140 mm	108,49	154,37	gb	131,27	186,78
	681004121	KRS pieslēguma trejgbals 90°, Ø160 mm	110,41	157,10	gb	133,60	190,10
	681004124	KRS pieslēguma trejgbals 90°, Ø180 mm	115,70	164,63	gb	140,00	199,20
	681004122	KRS pieslēguma trejgbals 90°, Ø200 mm	121,71	173,18	gb	147,27	209,55
	681004125	KRS pieslēguma trejgbals 90°, Ø250 mm	142,69	203,03	gb	172,65	245,66
	681004135	KRS pieslēguma trejgbala manšete, Ø140 mm	18,30	26,04	gb	22,14	31,50
	681004131	KRS pieslēguma trejgbala manšete, Ø160 mm	19,36	27,55	gb	23,43	33,34
	681004136	KRS pieslēguma trejgbala manšete, Ø180 mm	20,75	29,52	gb	25,11	35,73
	681004132	KRS pieslēguma trejgbala manšete, Ø200 mm	23,24	33,07	gb	28,12	40,01
	681004137	KRS pieslēguma trejgbala manšete, Ø250 mm	26,26	37,36	gb	31,77	45,20
	681004126	KRS pieslēguma trejgbals 45°, Ø140 mm	161,69	230,06	gb	195,64	278,37
	681004127	KRS pieslēguma trejgbals 45°, Ø160 mm	163,85	233,14	gb	198,26	282,10
	681004128	KRS pieslēguma trejgbals 45°, Ø180 mm	181,27	257,92	gb	219,34	312,09
	681004129	KRS pieslēguma trejgbals 45°, Ø200 mm	186,07	264,75	gb	225,14	320,35
	681004130	KRS pieslēguma trejgbals 45°, Ø250 mm	224,99	320,13	gb	272,24	387,36
	681004820	KRS noslēgmanšete EW, Ø140 mm	8,38	11,92	gb	10,14	14,43
	681004821	KRS noslēgmanšete EW, Ø160 mm	8,77	12,48	gb	10,61	15,10
	681004822	KRS noslēgmanšete EW, Ø180 mm	9,12	12,98	gb	11,04	15,71
	681004823	KRS noslēgmanšete EW, Ø200 mm	9,50	13,52	gb	11,50	16,36
	681004824	KRS noslēgmanšete EW, Ø250 mm	10,56	15,03	gb	12,78	18,18
	681004138	KRS noslēgmanšete DW, Ø140 mm	11,75	16,72	gb	14,22	20,23
	681004133	KRS noslēgmanšete DW, Ø160 mm	14,38	20,46	gb	17,40	24,76
	681004139	KRS noslēgmanšete DW, Ø180 mm	12,93	18,40	gb	15,65	22,27
	681004134	KRS noslēgmanšete DW, Ø200 mm	14,07	20,02	gb	17,02	24,22
	681004140	KRS noslēgmanšete DW, Ø250 mm	15,69	22,32	gb	18,98	27,01

EW - noslēgmanšete pieslēguma caurulei
DW - noslēgmanšete pieslēguma trejgabalam

Kerstar izstrādājumi un papildelementi (Izstrādājums uz pasūtījumu. Pasūtījuma izpildes laiks 3 – 4 nedēļas)

Izstrādājums		Cena bez PVN		gb	Cena ar PVN	
		LVL	EUR		kpl	LVL
	KRS Adapteris apkures iekārtai, Ø140 mm	76,07	108,24	gb	92,04	130,96
	KRS Adapteris apkures iekārtai, Ø160 mm	80,40	114,40	gb	97,28	138,42
	KRS Adapteris apkures iekārtai, Ø180 mm	84,08	119,64	gb	101,74	144,76
	KRS Adapteris apkures iekārtai, Ø200 mm	89,51	127,36	gb	108,31	154,11
	KRS Adapteris apkures iekārtai, Ø250 mm	101,24	144,05	gb	122,50	174,30
	681004881 KRS sienas stiprinājums, Ø140 mm	18,55	26,39	gb	22,45	31,94
	681004882 KRS sienas stiprinājums, Ø160 mm	13,57	19,31	gb	16,42	23,36
	681004883 KRS sienas stiprinājums, Ø180 mm	21,61	30,75	gb	26,15	37,21
	681004884 KRS sienas stiprinājums, Ø200 mm	22,29	31,72	gb	26,97	38,37
	681004885 KRS sienas stiprinājums, Ø250 mm	26,59	37,83	gb	32,17	45,77
	681004834 KRS sienas statiskais stiprinājums, Ø140 mm	15,31	21,78	gb	18,53	26,37
	681004163 KRS sienas statiskais stiprinājums, Ø160 mm	16,63	23,66	gb	20,12	28,63
	681004835 KRS sienas statiskais stiprinājums, Ø180 mm	16,63	23,66	gb	20,12	28,63
	681004164 KRS sienas statiskais stiprinājums, Ø200 mm	16,63	23,66	gb	20,12	28,63
	681004836 KRS sienas statiskais stiprinājums, Ø250 mm	19,84	28,23	gb	24,01	34,16
	681004837 KRS starpspāru stiprinājums, Ø140 mm	7,21	10,26	gb	8,72	12,41
	681004165 KRS starpspāru stiprinājums, Ø160 mm	7,44	10,59	gb	9,00	12,81
	681004838 KRS starpspāru stiprinājums, Ø180 mm	7,97	11,34	gb	9,64	13,72
	681004166 KRS starpspāru stiprinājums, Ø200 mm	8,25	11,74	gb	9,98	14,20
	681004839 KRS starpspāru stiprinājums, Ø250 mm	9,11	12,96	gb	11,02	15,68
	681004844 KRS konuss, Ø140 mm	31,07	44,21	gb	37,59	53,49
	681004184 KRS konuss, Ø160 mm	32,49	46,23	gb	39,31	55,93
	681004845 KRS konuss, Ø180 mm	35,97	51,18	gb	43,52	61,92
	681004185 KRS konuss, Ø200 mm	38,62	54,95	gb	46,73	66,49
	681004846 KRS konuss, Ø250 mm	46,33	65,92	gb	56,06	79,77
	681001123 KRS konusa lietussargs, Ø140 mm	16,50	23,48	gb	19,97	28,41
	681001124 KRS konusa lietussargs, Ø160 mm	17,92	25,50	gb	21,68	30,85
	681001125 KRS konusa lietussargs, Ø180 mm	21,52	30,62	gb	26,04	37,05
	681001126 KRS konusa lietussargs, Ø200 mm	23,08	32,84	gb	27,93	39,74
	681001127 KRS konusa lietussargs, Ø250 mm	24,73	35,19	gb	29,92	42,57
	681004864 KRS izeja caur jumtu 0°, Ø140 mm	49,54	70,49	gb	59,94	85,29
	681004198 KRS izeja caur jumtu 0°, Ø160 mm	55,48	78,94	gb	67,13	95,52
	681004865 KRS izeja caur jumtu 0°, Ø180 mm	55,48	78,94	gb	67,13	95,52
	681004199 KRS izeja caur jumtu 0°, Ø200 mm	61,58	87,62	gb	74,51	106,02
	681004866 KRS izeja caur jumtu 0°, Ø250 mm	67,14	95,53	gb	81,24	115,59

Kerastar izstrādājumi un papildelementi (Izstrādājums uz pasūtījumu. Pasūtījuma izpildes laiks 3 – 4 nedēļas)

Izstrādājums			Cena bez PVN		gb kpl	Cena ar PVN	
			LVL	EUR		LVL	EUR
	681004851	KRS izeja caur jumtu 3 -15°, Ø140 mm	102,28	145,53	gb	123,76	176,09
	681004190	KRS izeja caur jumtu 3 -15°, Ø160 mm	102,28	145,53	gb	123,76	176,09
	681004852	KRS izeja caur jumtu 3 -15°, Ø180 mm	112,37	159,89	gb	135,97	193,47
	681004191	KRS izeja caur jumtu 3 -15°, Ø200 mm	112,37	159,89	gb	135,97	193,47
	681004853	KRS izeja caur jumtu 3 -15°, Ø250 mm	129,15	183,76	gb	156,27	222,35
	681004854	KRS izeja caur jumtu 16 - 25°, Ø140 mm	107,42	152,84	gb	129,98	184,94
	681004192	KRS izeja caur jumtu 16 - 25°, Ø160 mm	107,42	152,84	gb	129,98	184,94
	681004855	KRS izeja caur jumtu 16 - 25°, Ø180 mm	119,01	169,34	gb	144,00	204,89
	681004193	KRS izeja caur jumtu 16 - 25°, Ø200 mm	119,01	169,34	gb	144,00	204,89
	681004856	KRS izeja caur jumtu 16 - 25°, Ø250 mm	136,57	194,32	gb	165,25	235,13
	681004857	KRS izeja caur jumtu 26 - 35°, Ø140 mm	116,62	165,94	gb	141,11	200,78
	681004194	KRS izeja caur jumtu 26 - 35°, Ø160 mm	116,62	165,94	gb	141,11	200,78
	681004858	KRS izeja caur jumtu 26 - 35°, Ø180 mm	128,70	183,12	gb	155,73	221,58
	681004195	KRS izeja caur jumtu 26 - 35°, Ø200 mm	128,70	183,12	gb	155,73	221,58
	681004859	KRS izeja caur jumtu 26 - 35°, Ø250 mm	148,95	211,94	gb	180,23	256,44
	681004861	KRS izeja caur jumtu 36 - 45°, Ø140 mm	128,89	183,39	gb	155,96	221,91
	681004196	KRS izeja caur jumtu 36 - 45°, Ø160 mm	128,89	183,39	gb	155,96	221,91
	681004862	KRS izeja caur jumtu 36 - 45°, Ø180 mm	143,57	204,28	gb	173,72	247,18
	681004197	KRS izeja caur jumtu 36 - 45°, Ø200 mm	143,57	204,28	gb	173,72	247,18
	681004863	KRS izeja caur jumtu 36 - 45°, Ø250 mm	167,42	238,22	gb	202,58	288,25
	681004841	KRS lietuskraģa, Ø140 mm	20,79	29,58	gb	25,16	35,80
	681004182	KRS lietuskraģa, Ø160 mm	22,06	31,39	gb	26,69	37,98
	681004842	KRS lietuskraģa, Ø180 mm	22,69	32,28	gb	27,45	39,06
	681004183	KRS lietuskraģa, Ø200 mm	21,34	30,36	gb	25,82	36,74
	681004843	KRS lietuskraģa, Ø250 mm	21,96	31,25	gb	26,57	37,81
	681004876	KRS distancgredzens, Ø140 mm	15,96	22,71	gb	19,31	27,48
	681004877	KRS distancgredzens, Ø160 mm	16,26	23,14	gb	19,67	27,99
	681004878	KRS distancgredzens, Ø180 mm	16,49	23,46	gb	19,95	28,39
	681004879	KRS distancgredzens, Ø200 mm	17,63	25,09	gb	21,33	30,35
	681004880	KRS distancgredzens, Ø250 mm	18,32	26,07	gb	22,17	31,55
	681001204	Rapid ugunsdroša ķīte 310 ml	4,09	5,82	gb	4,95	7,04

Tīršanas un pieslēguma trejgabalu augstumi

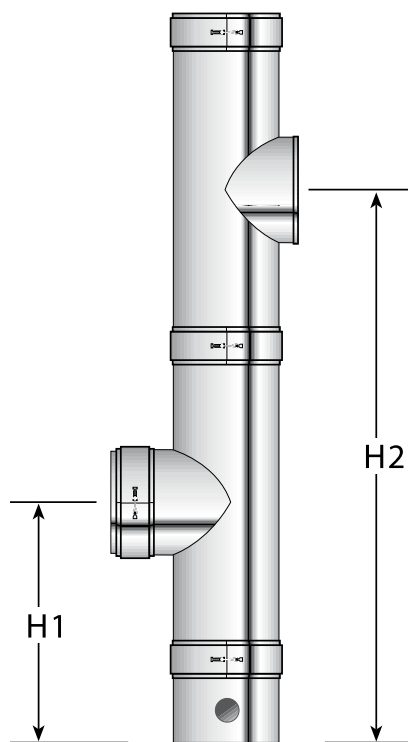

Grīdas montāža

Ja tiek izmantots pieslēgums 90°

H2+papildus 1 caurules elements

D Ø mm	H1 (PA)	H2 (RA 90°)	165	330	665
visi Ø	0,67	1,335	1,50	1,665	2,00

Ja tiek izmantots pieslēgums 45°

H2+papildus 1 caurules elements

D Ø mm	H1 (PA)	H2 (RA 45°)	165	330	665
140	0,67	1,105	1,27	1,435	1,77
160	0,67	1,11	1,275	1,44	1,775
180	0,67	1,12	1,285	1,45	1,785
200	0,67	1,125	1,29	1,455	1,79
250	0,67	1,14	1,305	1,47	1,805

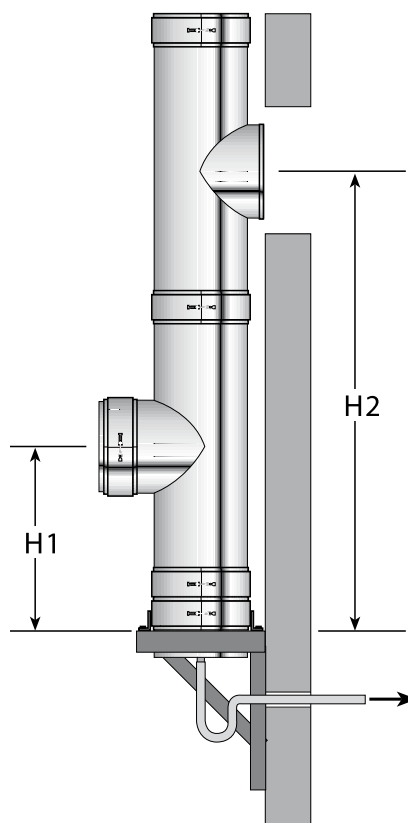

Sienas montāža

Ja tiek izmantots pieslēgums 90°

H2+papildus 1 caurules elements

D Ø mm	H1 (PA)	H2 (RA 90°)	165	330	665
visi Ø	0,36	1,025	1,19	1,355	1,69

Ja tiek izmantots pieslēgums 45°

H2+papildus 1 caurules elements

D Ø mm	H1 (PA)	H2 (RA 45°)	165	330	665
140	0,36	0,795	0,96	1,125	1,46
160	0,36	0,80	0,965	1,13	1,465
180	0,36	0,81	0,975	1,14	1,475
200	0,36	0,815	0,98	1,145	1,48
250	0,36	0,83	0,995	1,16	1,495

